



Powered Subwoofer System

OPERATION MANUAL

KEN KREISEL
DXD-808 and DXD-12012
Push-Pull-Pulsar Powered Subwoofers

IMPORTANT SAFETY INSTRUCTIONS



The lightning flash with arrowhead symbol, within an equilateral triangle, is intended to alert the user to the presence of uninsulated "dangerous voltage" within the product's enclosure that may be of sufficient magnitude to constitute a risk of electric shock to persons.



CAUTION:
TO PREVENT THE RISK OF ELECTRIC SHOCK, DO NOT REMOVE COVER (OR BACK). NO USER SERVICEABLE PARTS INSIDE. REFER SERVICING TO QUALIFIED SERVICE PERSONNEL.



The exclamation point symbol, within an equilateral triangle, is intended to alert the user to the presence of important operating and maintenance (servicing) instructions in the literature accompanying the product.

1. **READ INSTRUCTIONS** - All safety and operating instructions should be read before this product is operated.
2. **RETAIN INSTRUCTIONS** - The safety and operating instructions should be retained for future reference.
3. **HEED WARNINGS** - All warnings on this product and in the operating instructions should be adhered to.
4. **FOLLOW INSTRUCTIONS** - All operating and use instructions should be followed.
5. **WATER & MOISTURE** - Do **not** use this product near water - for example, near a bathtub, washbowl, kitchen sink, laundry tub, in a wet basement, near a swimming pool, or the like.
6. **ATTACHMENTS** - Do not use any attachments not recommended by the product manufacturer as they may cause hazards.
7. **ACCESSORIES** - Do not place this product on an unstable cart, stand, tripod, bracket, or table. The product may fall, causing serious injury to a child or adult, and serious damage to the product. Use only with accessories recommended by the manufacturer.
8. **WALL or CEILING MOUNTING** - This product should be mounted to a wall or ceiling only as recommended by the manufacturer.
9. **VENTILATION** - This product should be situated so that its location or position does not interfere with its proper ventilation. For example, this product should not be situated on a bed, sofa, rug, or similar surface that may block the ventilation openings; or placed in a built-in installation such as a bookcase or cabinet that may impede the flow of air through the ventilation openings.
10. **HEAT** - This product should be situated away from heat sources such as radiators, heat registers, stoves, or other equipment that produce heat.
11. **POWER SOURCE** - This product should be operated only from the type of power source indicated on the marking label. If you are unsure of the type of power supply to your home, consult your product dealer or local power company.
12. **POWER CORD PROTECTION** - Power-supply cords should be routed so that they are not likely to be walked on or pinched by items placed upon or against them, paying particular attention to cords at plugs, convenience receptacles, and the point at which they exit from the subwoofer.
13. **CAUTION:** To prevent electric shock, match wide blade of power plug to wide slot of receptacle and fully insert.
14. **OVERLOADING** - Do not overload wall outlets, extension cords, or integral convenience receptacles as this can result in a risk of fire or electric shock.
15. **CLEANING** - This product should be cleaned only as recommended by the manufacturer.
16. **NONUSE PERIODS** - The power cord of the subwoofer should be unplugged from the outlet when left unused for a long period of time.
17. **OBJECT & LIQUID ENTRY** - Care should be taken so that objects do not fall and liquids are not spilled onto the enclosure.
18. **DAMAGE REQUIRING SERVICE** - The subwoofer should be serviced by qualified service personnel when:
 - a. The power-supply cord or plug has been damaged.
 - b. Objects have fallen or liquid has been spilled into the subwoofer.
 - c. The subwoofer has been exposed to rain.
 - d. The subwoofer does not appear to operate normally or exhibits a marked change in performance.
 - e. The subwoofer has been dropped or damaged.
19. **SERVICING** - Do not attempt to service the product yourself, beyond what is described in these operating instructions.
20. **REPLACEMENT PARTS** - When replacement parts are required, be sure the service technician has used replacement parts specified by the manufacturer or have the same characteristics as the original part. Unauthorized substitutions may result in fire, electric shock, or other hazards.
21. **SAFETY CHECK** - Upon completion of any service or service of repairs to this product, ask the service technician to perform safety checks to determine that the product is in proper operating condition. All other servicing should be referred to qualified service personnel.

CONTENTS

INTRODUCTION	1
PRODUCT FEATURES	2
BEFORE YOU BEGIN.....	2
CABLES.....	3
CONNECTIONS & CONTROLS.....	3
PLACEMENT.....	5
INSTALLATION-Home Theater System Using Unbalanced RCA.....	7
INSTALLATION-Music System Using Unbalanced RCA's.....	9
INSTALLATION-Home Theater System Using Balanced XLR.....	11
INSTALLATION-DUO/QUATTRO.....	13
CALIBRATION.....	16
PROTECTION CIRCUITRY.....	18
CARE OF YOUR SUBWOOFER.....	18
TROUBLESHOOTING & SERVICE.....	19
SPECIFICATIONS.....	20

INTRODUCTION

Congratulations on your purchase of a KEN KREISEL subwoofer. This product represents the state-of-the-art in subwoofer performance and will provide you with years of listening pleasure when properly setup and cared for. We strongly urge you to read this owner's manual and follow the instructions provided to help you obtain maximum system performance.

PRIOR TO INSTALLATION

Please unpack the system carefully. This unit is heavy. Use caution when lifting or moving to avoid injury. Save the carton and all packaging materials for future use. Packing this unit in any other carton may result in damage when shipping that is not covered by the warranty. Fill out and return the warranty card to complete your product registration and record the serial number and purchase information in the space provided for your own records.

OPERATING ENVIRONMENT

Operating environment temperature 40°F to 95°F (4°C to 35°C) with less than 85% relative humidity. Do not install this product in a poorly ventilated area, or in locations exposed to high humidity, direct sunlight, or strong artificial light.

VENTILATION REQUIREMENTS

This product contains electronics that generate heat whenever powered. When installing this product, make sure to leave adequate space around the unit for proper ventilation to prevent excessive operating temperature. A minimum of 2" (50mm) clearance from all sides is suggested.

WARNING!

This equipment is not waterproof. To prevent a fire or shock hazard, do not expose this equipment to rain, moisture or any liquids. Do not place a container filled with liquid on or near this equipment (such as a drink or flower vase). To prevent a fire hazard, do not place an open flame (such as a lighted candle) on this product. To avoid electrical shock, do not open speaker enclosure or amp chassis cover. Please observe all warnings on the equipment itself. There are no user serviceable parts inside. Please refer all service questions to your authorized dealer.

CAUTION!

The standby function of this product will not completely shut off all power consumption from the AC outlet. Therefore, make sure this product is installed so that the main power switch is accessible. To avoid fire hazard, the AC power should be disconnected if the product is left unused for a long period of time (for example, when on vacation).

PRODUCT FEATURES

- KEN KREISEL's proprietary dual 8" or 12" Push-Pull-Pulsar Pressure Wavefront Sealed Box Subwoofer System
- Magnetically shielded for video use (20 oz. bucking magnet on 8" and 34 oz. on 12")
- FEA optimized motor structure including shorting ring for low distortion
- "Silent Running" Suspension (spider) provides linear travel at high excursion for low distortion
- High excursion ultralinear rubber surround
- High efficiency dual mono-block class D amplifiers optimized for low distortion & high impact deep bass
- High current push-pull dual cross-coupled monoblock amp design: 750+ watts RMS continuous/1250+ watts peak
- Line-level unbalanced (RCA), and balanced instrumentation type (XLR) inputs
- Balanced XLR pass through (direct pass thru, unbuffered)
- RCA signal sensing AUTO ON/OFF (defeatable), XLR input requires ALWAYS ON
- Variable volume control with a calibrated and locked REFERENCE LEVEL preset position
- Variable phase control (0° to 180°)
- Adjustable (40 to 160Hz) low-pass filter (12dB/octave, with BYPASS switch)
- Output maximizer circuit provides maximum clean sound output, and prevents driver over excursion, amp clipping, and excessive distortion
- Designed for optimum performance & frequency response when placed in the corner closest to the listening position
- Typical in-room frequency response of 15Hz-250Hz (DXD-808) and 10Hz-250Hz (DXD-12012)

BEFORE YOU BEGIN

Your new subwoofer provides for a number of installation options. Read all the installation information contained within this manual in order to determine which installation option is best for your system configuration.

When using a surround sound processor or receiver, be sure to set all controls to their GREEN DOT position to insure optimum performance. When using the XLR input be sure the ALWAYS ON power mode switch position is selected.

- Select appropriate AC Power source for subwoofer. Do NOT plug the power cord of the subwoofer into the switched outlet of a receiver or other piece of equipment. The power cord should be plugged directly into an AC outlet. Never simultaneously switch-on two or more DXD's with a common power switch.
NOTE: the AC powerline voltage varies according to country or region. Be sure that the AC power of the area where the unit will be installed matches the required voltage (e.g., 120VAC or 230VAC) indicated on the subwoofer's rear amplifier panel.
- Select appropriate signal connection type (XLR or RCA signal cable) to match your equipment
- Determine optimum subwoofer mounting location, which normally is the closest corner to where you sit
- Obtain any appropriate mounting hardware (i.e. accessory bracket kits for multiple subwoofer use in Duo/Quattro systems)
- Determine system configuration (e.g. music or surround sound system type for proper equipment settings & calibration)

NOTE: Consult your dealer or www.kreiselound.com for optional accessories that may be required to properly complete your system installation.

CABLES

When installing your new subwoofer using unbalanced RCA connections, you should use high quality shielded phono cables. Poor quality cables may pick up interference and result in hum or noise. Keep the length of cable as short as possible and route all input signal cables away from power cables to reduce the potential for induced hum and noise.

When using the balanced XLR connections, be certain to use a high quality cable that maintains proper connections to each pin, including the ground conductor. If an XLR cable that is improperly wired is used, subwoofer performance may be degraded and you may experience increased noise and/or hum. Due to various design differences between different brands & types of equipment (e.g. different ground methods for power supplies and signal reference) and long cables required in some installations, there is a potential for any product to pick up noise via the connections and/or connected equipment (via ground loops). If you have audible hum/buzz after completing your subwoofer connections, you may need to modify your equipment's cables, routing, or connection methods (power line connections and/or signal cables). Visit our web site www.kreiselound.com for upcoming low noise XLR cables and RCA to XLR adapter cables which may benefit your system setup.

CONNECTIONS & CONTROLS (see Figures 1a & 1b)

XLR Balanced Input [1]

Professional instrumentation type balanced XLR input. Note: XLR & RCA inputs are electronically summed together.

XLR Direct Pass-Thru (XLR Output) [2]

Balanced XLR direct passive pass through (unbuffered)

RCA Input [3]

Consumer style unbalanced RCA inputs. Note: RCA & XLR inputs are electronically summed together.

Variable Low-pass Filter: 40Hz to 160Hz [4]

This control allows you to adjust the upper limit of the subwoofer's frequency response from 40Hz to 160Hz. The subwoofer's output level will be reduced above the frequency this control is set to. You should set the crossover frequency to obtain a smooth and seamless transition from the subwoofer to the main speakers in your system. If your main speakers are smaller units with limited low frequency output, start with a higher frequency (such as 100-120Hz). With larger speakers that have greater low frequency output, you might start with this control set lower (such as 80-100Hz). ***If you are using a surround receiver or processor, be sure to set the DXD's LOW-PASS FILTER switch to its BYPASS (OFF) position which will totally bypass this VARIABLE LOW-PASS FILTER for optimum sound.***

Variable Phase - 0° to 180° [5]

This control allows you to alter the phase of the subwoofer's output signal up to 180° to correct for a possible mismatch and resulting cancellation between the subwoofer and your main speakers/amplifier. To adjust, listen to the system with music playing and rotate the knob from 0 to 180 and listen for a change in low frequency output. The correct position will have a greater amount of apparent low frequency output.

BASS LEVEL [6]

This control allows you to adjust the output level of the subwoofer to match the main speakers in your system. For use with most surround sound receivers/processors, set the BASS LEVEL to the locked "REFERENCE LEVEL" position indicated by the GREEN DOT. The "REFERENCE LEVEL" position is calibrated to work with most surround sound systems once the receiver/processor levels are properly adjusted. For stereo systems, start with the DXD's BASS LEVEL at a low setting (e.g., -6dB) and proceed slowly from there until levels match. Use of test tones (from a receiver or processor's built-in setup menu function or test disc) and SPL meter are suggested for proper level matching of all speakers and your DXD subwoofer. Auto-calibration is available with many receivers.



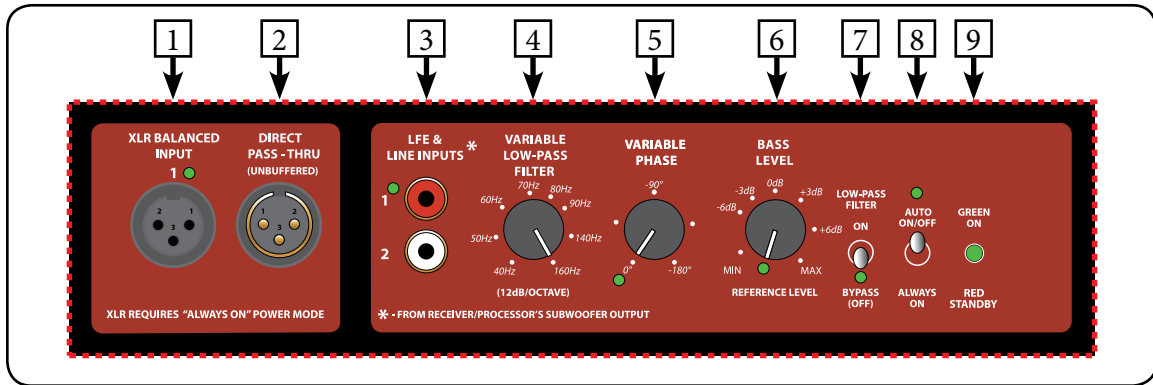

Figure 1a. Signal Connections & Controls (DXD-12012 shown)

Low Pass Filter Switch: LOW-PASS FILTER ON or BYPASS (OFF) [7]

This switch bypasses the subwoofer's built in electronic crossover circuitry from the signal path. This is required in installations which utilize a crossover external to the subwoofer, such as most home theater receivers/processors. When using a surround receiver/processor, set this switch to "BYPASS (OFF)" to turn-off the subwoofer's built in crossover. For stereo system installations which do not have an electronic crossover, we recommend you set this switch to "ON" as the internal crossover will improve performance if you do not have an external crossover.

Auto Turn ON Switch - AUTO ON/OFF or ALWAYS ON [8]

With this function in the "AUTO ON/OFF" position, your subwoofer can be safely left with the main power switch on continuously. The subwoofer will turn itself on automatically when an audio signal is present. If no signal is present for approximately 12 minutes, the unit will switch to standby mode (indicated by red power LED color). While in standby mode, your subwoofer will draw very minimal power. This function can be disabled by setting this switch to the "ALWAYS ON" position. **Note, the AUTO ON/OFF function operates only in conjunction with the RCA inputs. The XLR input requires that this switch be set to the ALWAYS ON position when operating.**

Power Indicator Light [9]

This LED indicates the operating mode of the subwoofer. Green indicates normal "ON" operation. Red indicates the subwoofer is in a low power "standby" mode.

Power Switch [10]

The master power switch is located on the lower half of the unit. This rocker style switch is the main on/off for the unit. This switch should be set to position **1 (up) for on**, and **0 (down) for off**. If the unit is to be left unused for an extended period of time (e.g. when you are away on vacation), the master power switch should be turned off, or the mains power cord disconnected.

AC Power Cord Inlet [11]

AC inlet power socket (IEC C18 style), mates to standard IEC C17 power cord (no earth ground).

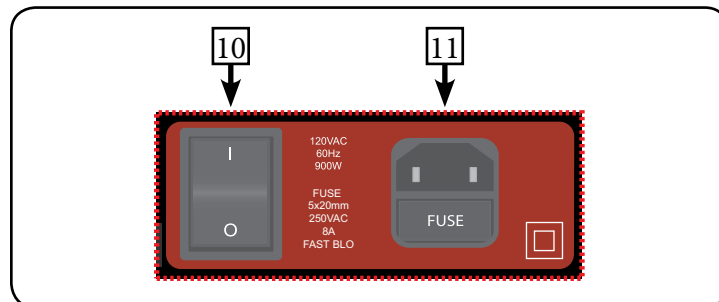

Figure 1b. Power Connection & Switch

PLACEMENT

While true subwoofers operate at extremely low frequencies which are primarily omni-directional, keep in mind that frequency response and output level can be **dramatically** influenced by where you place the subwoofer within the room. Placing the subwoofer in the wrong location may degrade sound quality, limit low frequency response and reduce maximum output level, substantially reducing your overall listening pleasure. Many rooms often end up with non-optimal placement, depending on the size and location of the furnishings within your room and if the possibility to reposition them exists. Finding the optimal location usually requires some experimentation to determine what sounds best in your room, from your listening position. We suggest you read the general guidelines below and setup the subwoofer in one of the suggested locations. Proceed to listen to the subwoofer multiple times, with it placed in a few different locations before settling on the final location. To do this, perform basic setup and listen to a familiar music track or movie scene. Then move the subwoofer to an alternate location & repeat listening to the same music track or movie scene. If you have a test CD and SPL meter (or other measurement equipment), performing a basic frequency response test can help you determine which location provides the best frequency response. A test CD with various low bass frequencies can be used along with an inexpensive handheld SPL meter to determine frequency response differences from one location to another.

General Guidelines

In most rooms the optimum DXD location is the closest front or rear corner (e.g., without a door or opening nearby - see Figure 2) to where you sit. This location typically offers the best bass impact with the deepest low frequency extension. The worst location for a subwoofer is far away from walls, near the center of your room (see Figure 2). Avoid central room locations whenever possible. When using a pair of subwoofers in stereo, it is preferable to place each subwoofer on a wall/corner near the satellite of the same channel.

This subwoofer includes magnetic shielding to reduce the amount of stray magnetic energy emitted from the speaker's motor structure. This allows greater flexibility when placing the unit as there is less stray magnetism that may affect other nearby devices. If any nearby equipment is sensitive to magnetism and operates abnormally after installing your subwoofer, increase the distance between the subwoofer and such equipment until normal operation is returned. Flat screen TV displays are not sensitive to magnetic fields.

CAUTION:

- 1. This subwoofer has electronics built into the cabinet and must be properly ventilated.**
- 2. Do not place the rear of cabinet against a wall, you must allow room for adequate ventilation of the amplifier (at least 2 inches).**
- 3. Do not place the subwoofer next to heat sources, such as furnace registers, radiators, etc.**
- 4. Do not place the subwoofer near sources of excessive moisture, such as evaporative coolers, humidifiers, etc.**
- 5. The power cord should be routed in such a way that it will not be walked on, pinched, cut, or compressed in any way that could result in damaging the insulation or wire. Damage to the power cord may result in a shock or fire hazard.**

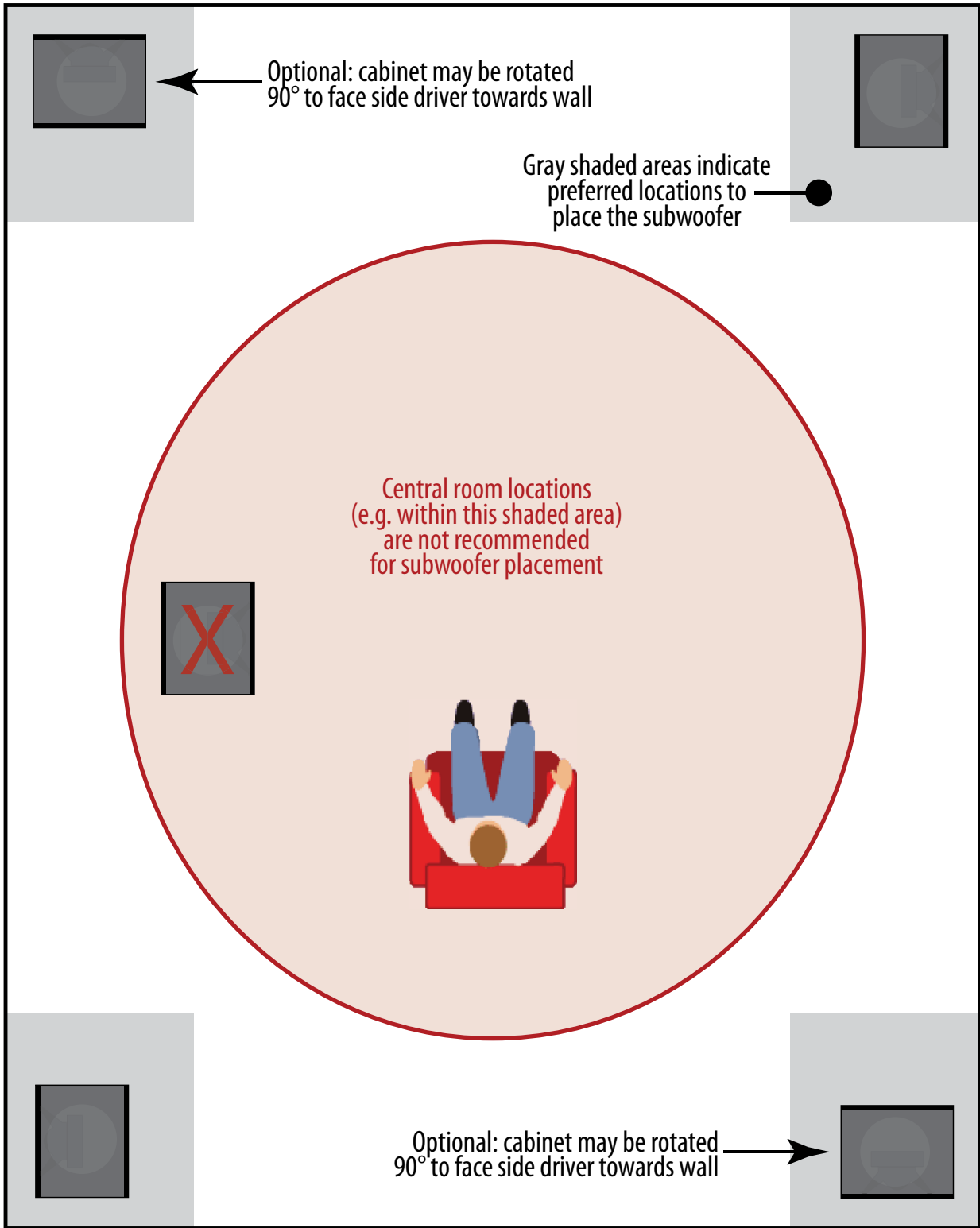

Figure 2. Subwoofer Placement

INSTALLATION

Home Theater System Using Unbalanced RCA

All connections for the subwoofer are located on the rear of the unit. **Figure 3** illustrates connection to a typical home theater receiver or processor with preamp level subwoofer output. Utilizing this method, the receiver or processor is the main control center for the system and it provides all the bass management (e.g. sending the low frequency signals from the satellite speaker channels & LFE for movies, to the subwoofer), and it provides a low-pass filtered signal (bass information only) to the subwoofer.

Most home theater receivers/processors have 1 "SUBWOOFER" output jack. For this type of equipment, connect a single high quality shielded RCA cable from your receiver's "SUBWOOFER" output jack to the subwoofer's input RCA marked with a green dot.

If your receiver or processor has multiple subwoofer outputs, you may have additional connection options. Consult the owner's manual for your receiver/processor to verify if these outputs are all the same. In most cases, you may use either of these outputs, and use a single high quality shielded RCA cable to connect one of your receiver/processor "SUBWOOFER" output jacks to the subwoofer's input RCA marked with a GREEN DOT (same as above). You may also connect 2 RCA cables (regular stereo pair) to both "SUBWOOFER" output jacks from your receiver/processor to both RCA inputs on the DXD subwoofer, but it is not recommended.

Home Theater Surround System (utilizing receiver/processor with internal crossover):

- Set crossover bypass switch to "**BYPASS (OFF)**" (indicated by GREEN DOT)
- The "VARIABLE LOW-PASS FILTER" frequency control knob has no effect when above switch is set to "**BYPASS (OFF)**"
- Turn the "BASS LEVEL" knob fully counter-clockwise to the "**REFERENCE LEVEL**" until you hear & feel a click
- Set the "VARIABLE PHASE" control knob to "**0**" (indicated by GREEN DOT)

NOTE:

GREEN DOTS indicate the correct control settings for most home theater systems with a receiver/processor that performs your bass management (including low-pass filter). Start with the controls set to the green dots & consult the owner's manual for your receiver/processor and perform a level calibration, to balance the output level for all speakers, including subwoofer.

MULTIPLE SUBWOOFERS - DUO/QUATTRO SYSTEM

When connecting multiple subwoofers (e.g. Duo or Quattro system) using RCA signal connections, you will need to use "Y" cables (signal splitters) to route your receiver/processor output to each woofer (see Figure 7). Another option is to use an XLR to RCA adapter to convert your receiver/processor signal output type to an XLR connection, which allows you to use the XLR "DIRECT PASS-THRU" (see Figures 5 & 6 for XLR wiring). Visit our web site at www.kreiselound.com for upcoming cables & accessories that may benefit your system installation.

NOTE:

When using multiple subwoofers, it is critical that the controls/adjustments are set the same on every subwoofer for proper audio performance. Volume, phase, and crossover (including bypass) must all be set to identical (reference) positions indicated by the green dots or sound quality & output may be reduced. When using multiple subwoofers, their input load is in parallel, which places greater load on your receiver/processor. Some equipment with high output impedance may not be able to sufficiently drive multiple subwoofers & may require a line driver/buffer.

CAUTION!

To reduce risk of shock or damage, connect AC power cord after all other connections have been completed.

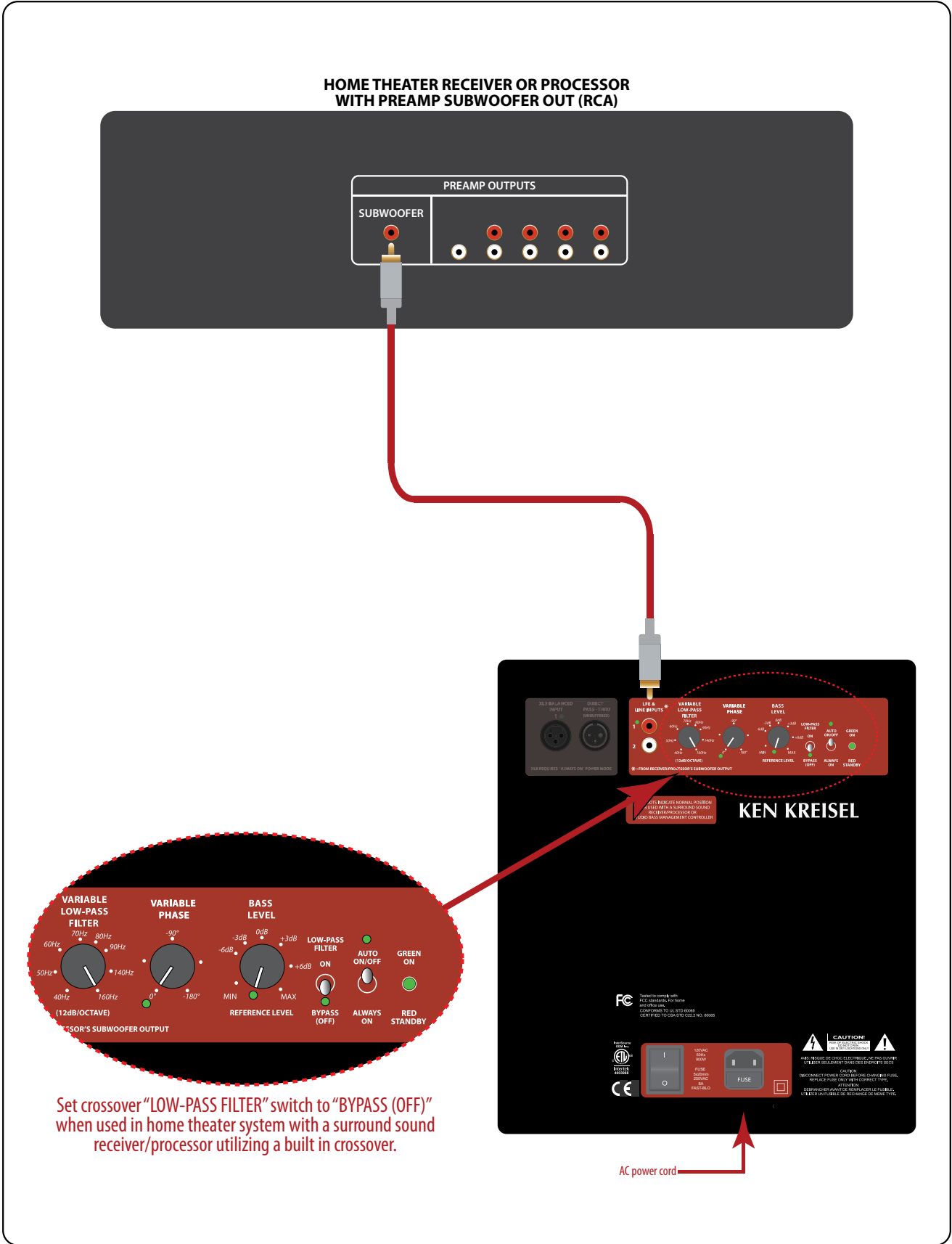

Figure 3. Home Theater Installation Using Unbalanced RCA Input

INSTALLATION

Music System Using Unbalanced RCA's

All connections for the subwoofer are located on the rear of the unit. **Figure 4** illustrates connection to a typical music preamp with stereo full range output. Utilizing this method, the preamp provides a full range signal from both left & right audio channels to the subwoofer. If your preamp does not offer an internal crossover or bass management functions, the subwoofer's built in controls will need to be properly set to blend the subwoofer output with the satellite speakers.

Full Range Output (music) vs Home Theater Use (subwoofer output)

This subwoofer is designed to operate from either a full range audio signal (when using the subwoofer's built-in crossover) or home theater (surround sound) processor/receiver with a "SUBWOOFER" output jack and built in low-pass filter & bass management. In both cases, proper control settings are required to achieve optimal system performance.

Music System (without external crossover):

- Set crossover bypass switch to "**LOW-PASS FILTER ON**"
- Adjust the "VARIABLE LOW-PASS FILTER" frequency control knob to blend the subwoofer output seamlessly with your main speakers
- Adjust the "BASS LEVEL" control knob to match the output level of the subwoofer to your main speakers
- Adjust the "VARIABLE PHASE" control knob to smoothly blend the output of the subwoofer to your main speakers *(refer to the section on system Calibration for further information)*

MULTIPLE SUBWOOFERS - DUO/QUATTRO SYSTEM

When connecting multiple subwoofers (e.g. Duo or Quattro system) using RCA signal connections, you will need to use "Y" cables (signal splitters) to route your receiver/processor output to each woofer. Another option is to use an XLR to RCA adapter to convert your receiver/processor signal output type to an XLR connection, which allows you to use the XLR "DIRECT PASS-THRU" (see Figures 5 & 6 for XLR wiring). Visit our web site at www.kreiselound.com for upcoming cables & accessories that may benefit your system installation.

NOTE:

When using multiple subwoofers, it is critical that the controls/adjustments are set the same on every subwoofer for proper audio performance. Volume, phase, and crossover (including bypass) must all be set to identical (reference) positions indicated by the green dots or sound quality & output may be reduced. When using multiple subwoofers, their input load is in parallel, which places greater load on your receiver/processor. Some equipment with high output impedance may not be able to sufficiently drive multiple subwoofers & may require a line driver/buffer.

CAUTION!

To reduce risk of shock or damage, connect AC power cord after all other connections have been completed. Do NOT plug the power cord of the subwoofer into the switched outlet of a receiver or other piece of equipment. The power cord should be plugged directly into an AC outlet.

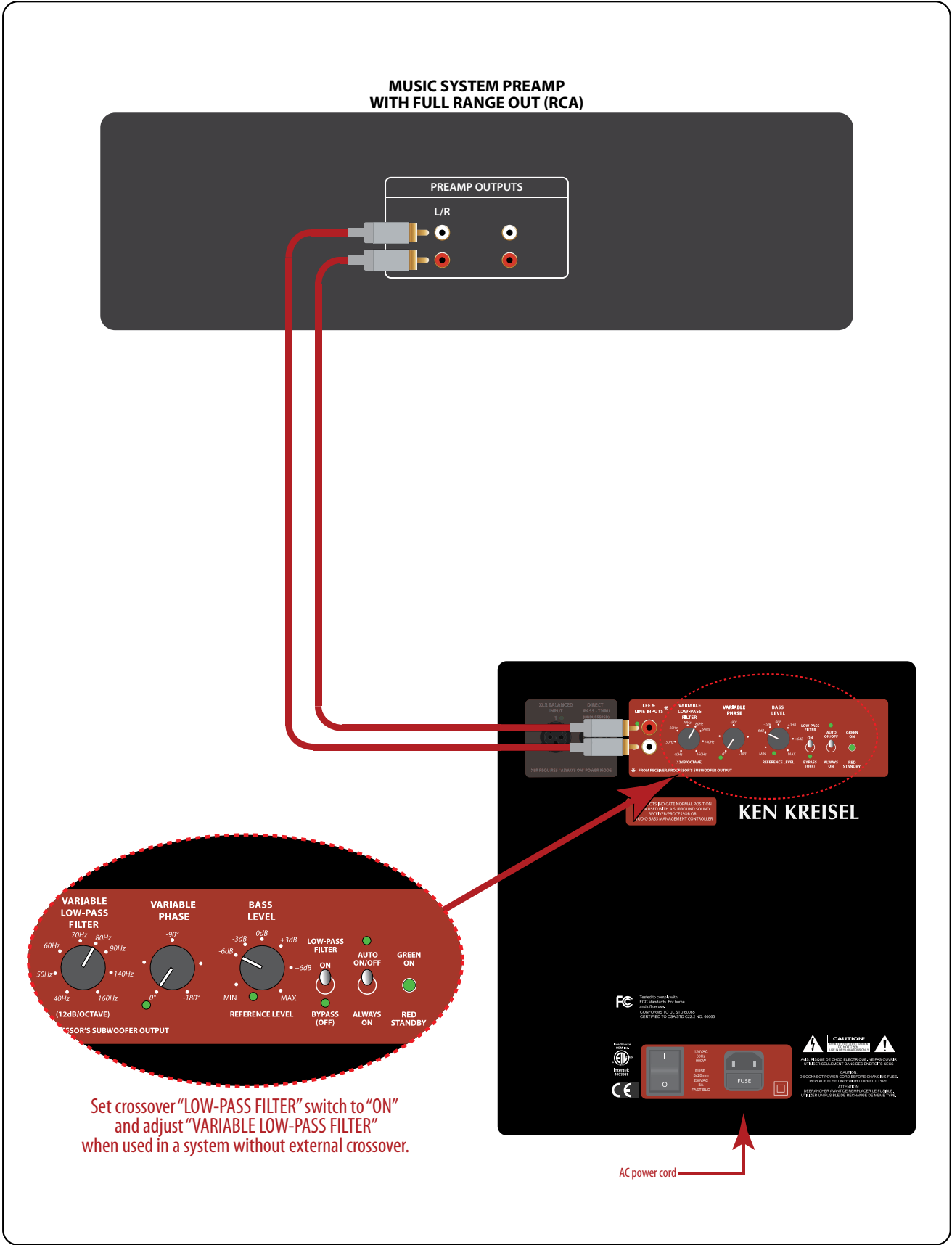

Figure 4. Music System Installation Using Unbalanced RCA Inputs

INSTALLATION

Home Theater System Using Balanced XLR

All connections for the subwoofer are located on the rear of the unit. **Figure 5** illustrates connection to a high end home theater preamp/processor with XLR subwoofer output.

Utilizing this method, the receiver or processor is the main control center for the system and it provides all the bass management (e.g. sending the low frequency signals from the satellite speaker channels & LFE channel, to the subwoofer), and it provides the low-pass filter for the subwoofer.

Home Theater Surround System (with surround receiver/processor with internal crossover):

- Set auto on/off switch to "**ALWAYS ON**"
- Set crossover bypass switch to "**BYPASS (OFF)**" (indicated by GREEN DOT)
- The "VARIABLE LOW-PASS FILTER" frequency control knob has no effect when above switch is set to "**BYPASS (OFF)**"
- Adjust the "BASS LEVEL" control knob to the "**REFERENCE LEVEL**" setting (indicated by GREEN DOT)
- Set the "VARIABLE PHASE" control knob to "**0**" (indicated by GREEN DOT)

NOTE:

GREEN DOTS indicate the correct control settings for most home theater systems with a receiver/processor that performs your bass management (including low-pass filter). Start with the controls set to the green dots (except for the auto on/off when using XLR input) and consult the owner's manual for your receiver/processor and perform a level calibration, to balance the output level for all speakers, including subwoofer.

MULTIPLE SUBWOOFERS - DUO/QUATTRO SYSTEM

When connecting multiple subwoofers (e.g. Duo or Quattro system) using XLR signal connections, you may wish to use the XLR "DIRECT PASS-THRU" output connection to simplify your installation (see Figures 5 and 6). This will allow you to run 1 long XLR cable from your processor's "SUBWOOFER" output jack to the 1st subwoofer's XLR input, and an additional short XLR cable connects the 1st subwoofer's XLR "DIRECT PASS-THRU" output to the input of the 2nd subwoofer in the signal chain (see Figure 5). If installing a Quattro system, additional short XLR cables can be used to connect the "XLR DIRECT PASS-THRU" output of the 2nd subwoofer to XLR input of the 3rd subwoofer, and another short XLR cable to connect the "XLR DIRECT PASS-THRU" output of the 3rd subwoofer to XLR input of the 4th subwoofer. If your processor does not provide an XLR output, you may use an RCA to XLR adapter cable to connect your receiver to the 1st subwoofer in a Duo/Quattro system, and use regular XLR cables to make the connections between additional subwoofers, as noted above. Visit our web site at www.kreiselound.com for upcoming cables & accessories that may benefit your system installation.

NOTE:

When using multiple subwoofers, it is critical that the controls/adjustments are set the same on every subwoofer for proper audio performance. Volume, phase, and crossover (including bypass) must all be set to identical (reference) positions indicated by the GREEN DOT or sound quality & output may be reduced. When using multiple subwoofers, their input load is in parallel, which places greater load on your receiver/processor. Some equipment with high output impedance may not be able to sufficiently drive multiple subwoofers & may require a line driver/buffer.

CAUTION!

To reduce risk of shock or damage, connect AC power cord after all other connections have been completed. Do NOT plug the power cord of the subwoofer into the switched outlet of a receiver or other piece of equipment. The power cord should be plugged directly into an AC outlet.

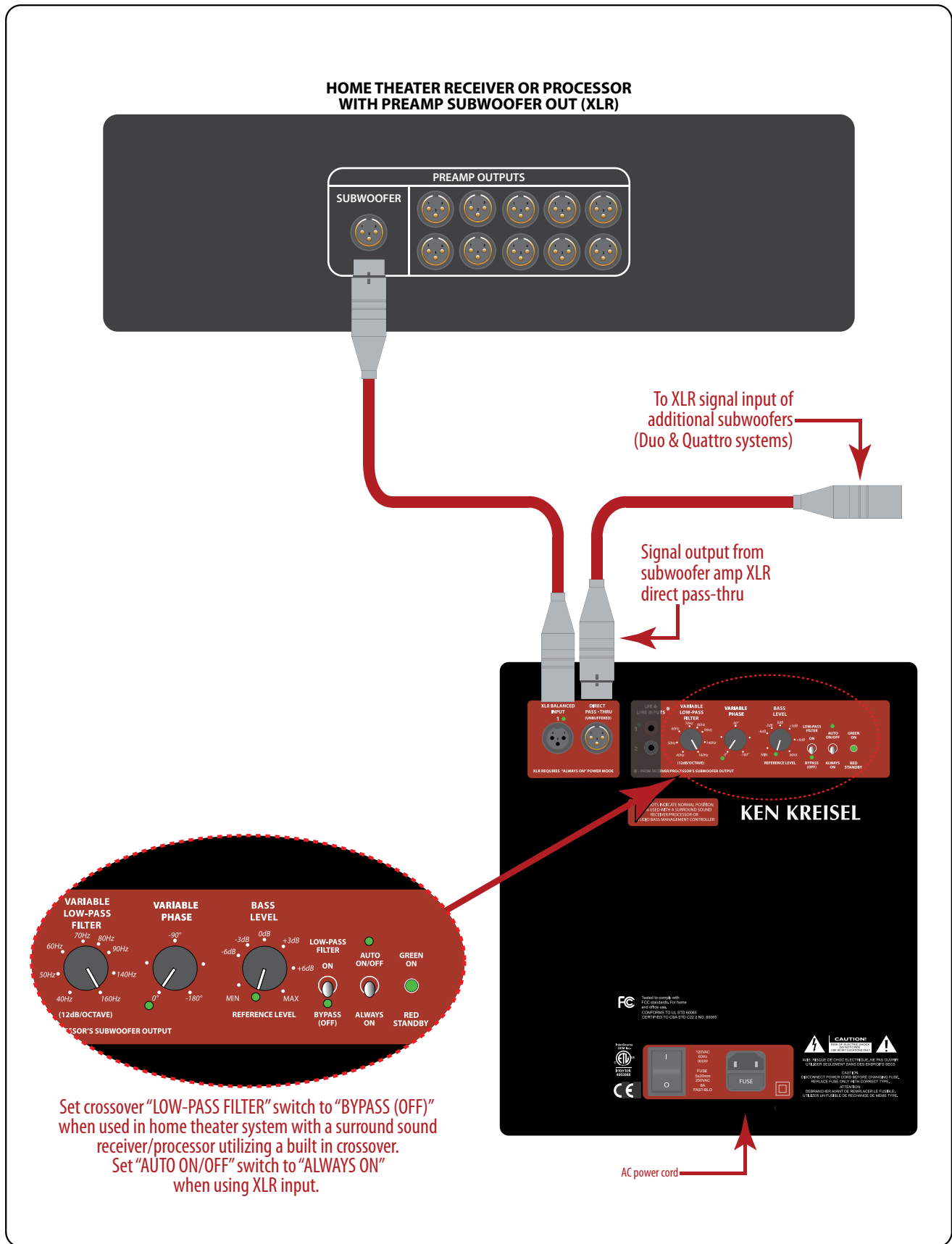





Figure 5. Home Theater Installation Using Balanced XLR Input

INSTALLATION

Duo/Quattro Hardware & Connections

When using 2 or 4 subwoofers in a Duo or Quattro configuration, mounting brackets are required to properly secure the subwoofers together. Three different stacking bracket kits are available to suit different mounting configurations:

STACKING BRACKET KITS	
<small>NOTE: each kit sold separately. NOTE: screws are 1/4" -20 x 5/8"</small>	Kit 1: <small>(P/N: SBK-5MM)</small> • 4 thick (5mm) rubber pads (50x50mm, with adhesive) 
	Kit 2: <small>(P/N: SBK-2S)</small> • 4 thin (3mm) rubber pads (50x50mm)  • 2 small brackets with 8 screws 
	Kit 3: <small>(P/N: SBK-1L)</small> • 1 large bracket with 4 screws (used only on DXD-12012) 

Refer to the instructions included with the stacking bracket kit for instructions how to properly install them. Consult your place of purchase or www.kreiselound.com for more information regarding product accessories that may be required for proper system setup.

All connections for the subwoofer are located on the rear of the unit. **Figure 5 & 6** illustrate the connections for a typical multiple subwoofer system (Duo/Quattro) using XLR cables & the subwoofer's built in XLR "DIRECT PASS-THRU" feature. You may use this method of connection if your receiver/processor offers an XLR subwoofer output jack. If your receiver/processor only offers an RCA subwoofer output jack, you will require an adapter cable that converts the RCA output to an XLR style connector in order to use the XLR "DIRECT PASS-THRU" feature.

Home Theater System (with receiver/processor with internal crossover & XLR's):

- Set auto on/off switch to "**ALWAYS ON**"
- Set crossover bypass switch to "**BYPASS (OFF)**" (indicated by green dot)
- The "VARIABLE LOW-PASS FILTER" frequency control knob has no effect when above switch is set to "**BYPASS (OFF)**"
- Adjust the "BASS LEVEL" control knob to the "**REFERENCE LEVEL**" setting (indicated by green dot)
- Set the "VARIABLE PHASE" control knob to "**0**" (indicated by green dot)

If you do not wish to use the XLR "DIRECT PASS-THRU" feature, you may connect your Duo/Quattro system subwoofer using regular high quality RCA cables if your receiver offers multiple RCA subwoofer output jacks. If your receiver has only 1 available subwoofer output jack, you will need to purchase RCA Y-cables (a.k.a. signal splitters) in order to connect your woofers as shown in Figure 7.

Home Theater System (utilizing receiver/processor with internal crossover & RCA's):

- Set crossover bypass switch to "**BYPASS (OFF)**" (indicated by green dot)
- The "VARIABLE LOW-PASS FILTER" frequency control knob has no effect when above switch is set to "**BYPASS (OFF)**"
- Adjust the "BASS LEVEL" control knob to the "**REFERENCE LEVEL**" setting (indicated by green dot)
- Set the "VARIABLE PHASE" control knob to "**0**" (indicated by green dot)

CAUTION!

To reduce risk of shock or damage, connect AC power cord after all other connections have been completed. Do NOT plug the power cord of the subwoofer into the switched outlet of a receiver or other piece of equipment. The power cord should be plugged directly into an AC outlet.

SETUP NOTES:

When used in Duo/Quattro systems, the controls on each subwoofer MUST be set identical to one another for proper performance.

When used in Duo/Quattro systems, the input impedance of each subwoofer is connected in parallel, lowering the total input impedance as follows:

- Single subwoofer XLR input = 15k
- Duo system combined XLR inputs = 7.5k
- Quattro system combined XLR inputs = 3.75k

Some equipment with high output impedance may not be able to properly drive multiple subwoofers & may require a line driver/buffer.

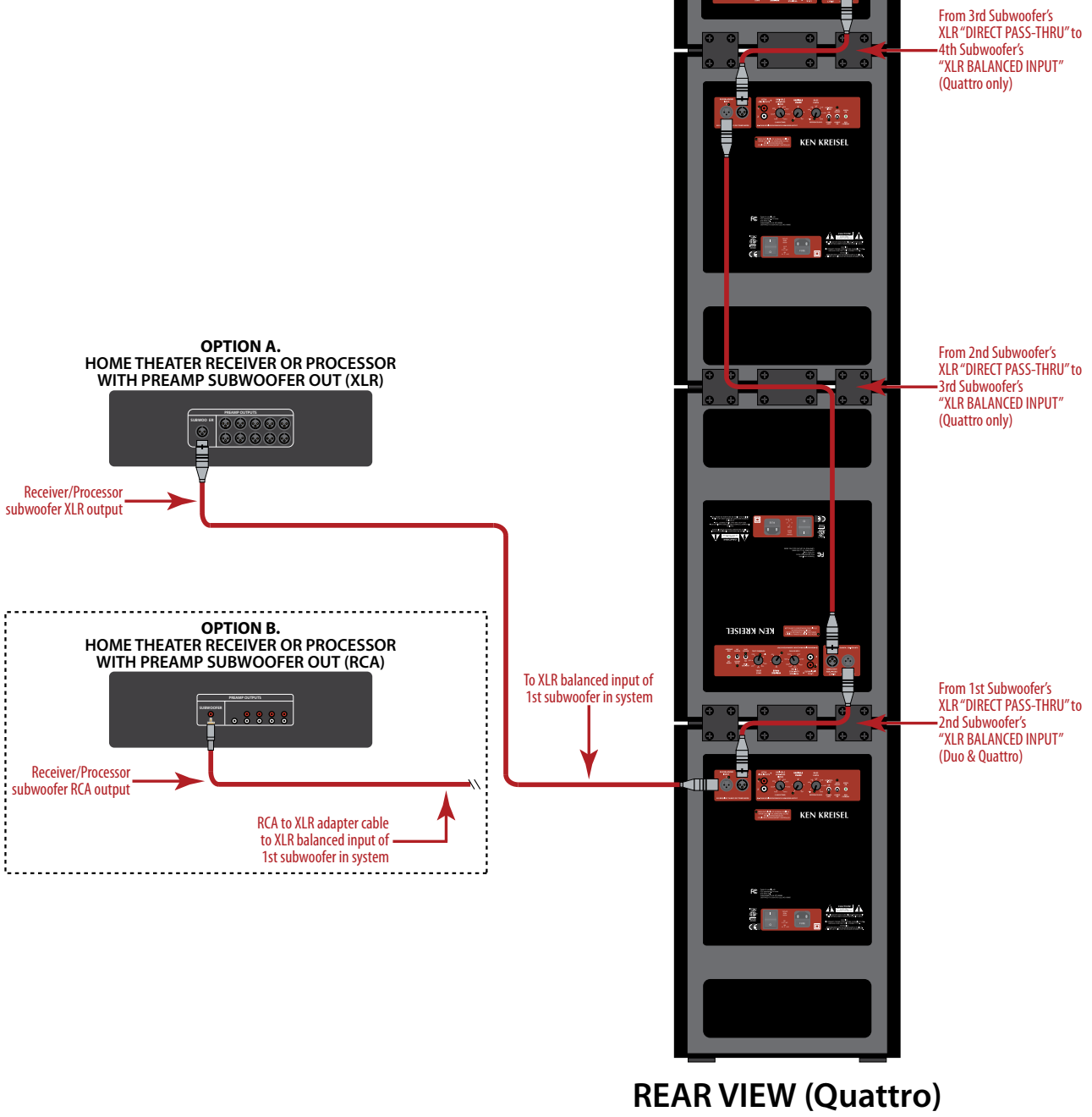

Figure 6. Duo/Quattro Installation Using Balanced XLR Input

SETUP NOTES:

When used in Duo/Quattro systems, the controls on each subwoofer **MUST** be set identical to one another for proper performance.

When used in Duo/Quattro systems, the input impedance of each subwoofer is connected in parallel, lowering the total input impedance as follows:

- Single subwoofer RCA input = 8k
- Duo system combined RCA inputs = 4k
- Quattro system combined RCA inputs = 2k

Some equipment with high output impedance may not be able to properly drive multiple subwoofers & may require a line driver/buffer.

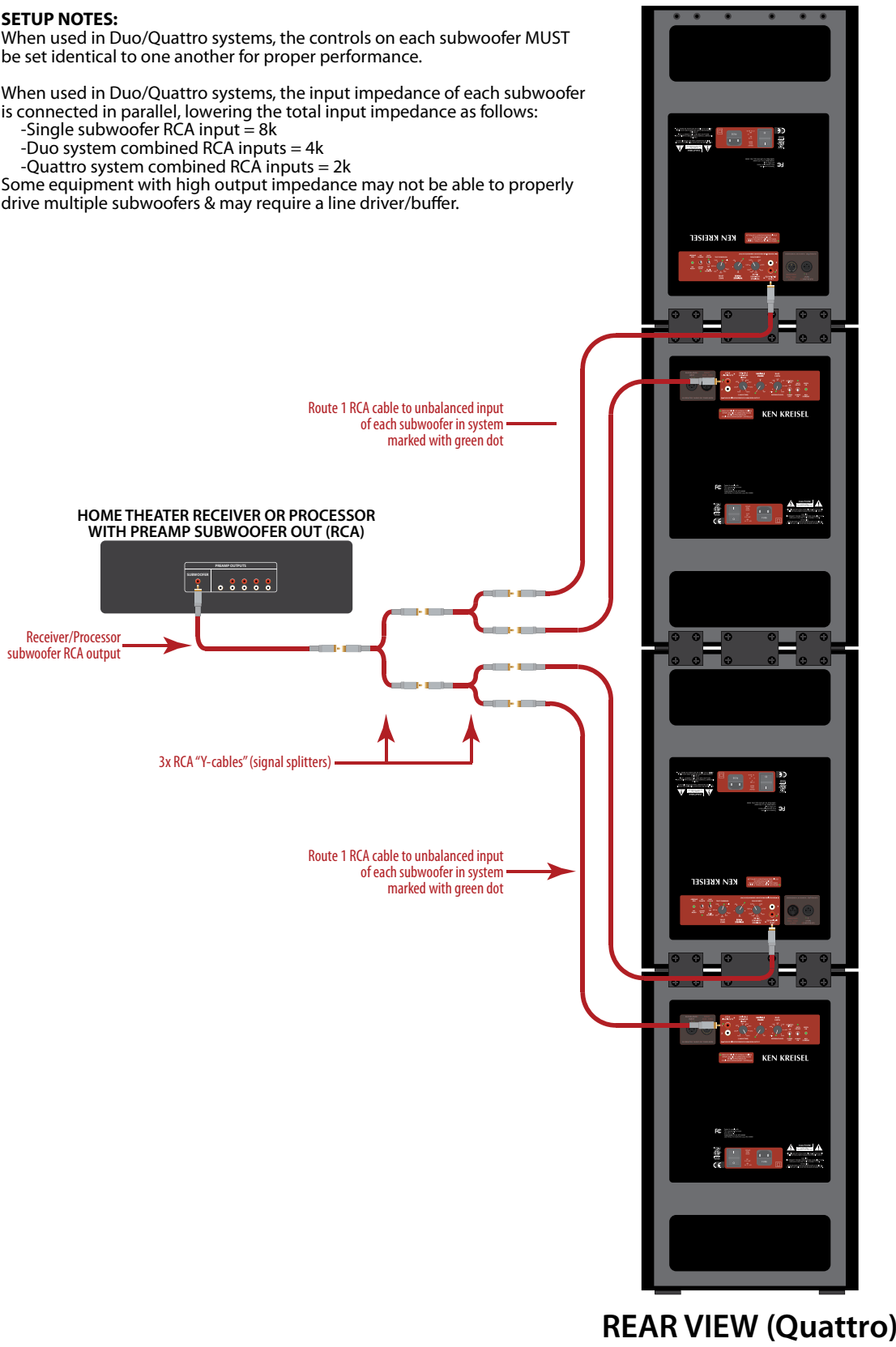

Figure 7. Duo/Quattro Installation Using Unbalanced RCA Input

CALIBRATION

For optimal performance, you should calibrate your system to ensure proper level matching between all speakers and the proper setting of all controls (including crossover frequency, phase, and any channel delays your receiver/processor may offer). This procedure will vary depending on system configuration and the information below is provided as a basic guide to assist you. Refer to the owner's manual for your receiver/processor for information on performing the steps required to enter their setup mode and adjust any applicable settings.

After all connections have been made, turn on the AC power to your system, starting with the first piece of source equipment in the signal chain (such as a CD or DVD player), then power on any dedicated equalizer, then power on your receiver/processor/amplifier(s), and last but not least, power on the subwoofer. A few seconds after powering on the subwoofer, the LED should turn green indicating the unit is "ON". If there is music playing from your source, you should hear sound if the subwoofer is receiving a signal and the volume control set above minimum (or to "REFERENCE LEVEL"). Verify that sound is coming from the subwoofer before proceeding with system calibration (it may be necessary to walk up to the subwoofer and listen or feel the unit to detect if it's operational when playing at low volume). If the subwoofer is not operating, and the LED is green, recheck all your signal cable connections to the subwoofer first, then verify if the subwoofer's control settings match the settings shown in the illustrations for your connection method. If the signal connections and subwoofer controls are correct, and AC power is applied to the subwoofer and it is powered on (indicated by a green LED), you may need to verify if your receiver/processor is properly set to output signal from the jack you used to connect the subwoofer. You may need to enter your receiver's/processor's setup mode and adjust any applicable speaker settings to properly match your system configuration before your receiver/processor outputs a signal from the subwoofer output jack.

Receiver/Processor With Automated Setup & Calibration Function

After you have verified the subwoofer is operational, you should perform the auto-setup routine on your receiver/processor (if available). Many newer home theater receivers/processors combine a measurement microphone and an automated setup routine to assist you with proper setting of speaker levels, crossover frequency, speaker delay and phase. Consult the owner's manual for your receiver/processor for further instructions on how to perform the setup routine. After the auto-setup routine is complete, verify the final settings the receiver/processor selected to ensure there are no erroneous settings (e.g. the settings should match your system configuration). Some settings to verify include:

- Number of speakers (e.g. 7.1 or 5.1 system, etc.)
- Type/size of speakers (e.g. small or large front/surround and set subwoofer to yes/on)
- Crossover point should be similar for identical speakers (e.g. if your system using 3 of the same speakers for all front channels, verify the receiver/processor selected the same crossover point for all these channels)
- Crossover frequency should correspond with speaker size & low frequency response (e.g. large speakers may be able to use a lower crossover frequency such as 80Hz and smaller speakers may require a higher frequency such as 100-150Hz)
- Gain settings for each channel should be reasonably close (e.g. if the speakers are placed at even distances, the gain setting for each channel should typically be within a couple dB from channel to channel). If the receiver/processor gain trim setting for the subwoofer channel is a large value (e.g. +12 or -12dB) verify that you have the subwoofer "BASS LEVEL" control set to "REFERENCE LEVEL".
- Low subwoofer gain/trim settings (on your receiver/processor) effect the operation of the "AUTO ON/OFF" signal sensing circuit. If your receiver/processor gain is set to a low values (e.g. attenuating the signal -6dB or more) this reduces the signal available to properly "turn on" the subwoofer when using the "AUTO ON/OFF" feature. If your subwoofer turns off unexpectedly when watching movies at low volumes, you may wish to increase the receiver's/processor's subwoofer gain trim, and manually reduce the volume using the subwoofer's "BASS LEVEL" control to maintain proper balance.
- Polarity/phase
- Eq settings; if your receiver/processor allows you to see the eq settings for each channel, verify that it is not adding any extra "limiter", or "HPF" to the subwoofer channel, and that it is not adding a high level of boost (e.g. >+3dB) or cut (e.g. -10db)

NOTE:

In some installations, automated room eq algorithms may make undesired changes to the subwoofer signal settings trying to obtain what they believe is the best room response curve. In some systems these changes have been known to degrade the overall sound quality of the subwoofer. If using a receiver/processor with automated room eq function, we advise you listen to the system first with the eq disabled, then again with the eq enabled, to determine if the changes are beneficial.

Receiver/Pre-amp Without Automated Setup

Older receivers and/or music preamps may not provide an automated setup function. With these systems, optimal calibration usually requires some type of test equipment be utilized to provide test tones and take measurements to properly calibrate your system. Some equipment you may use for this includes:

- Test signal source; pink noise and/or sine wave of various frequencies (CD, DVD, your receiver/preamp, or external measurement equipment)
- SPL meter (low cost handheld versions can be purchased online)
- RTA or other frequency response measurement tool (optional)
- Start with a quiet room free of excess background noise (e.g. people talking, kids playing, dogs barking, etc.).
- Verify that subwoofer control settings match illustrations for your type of system configuration
- Set any receiver/pre-amp speaker settings at an appropriate starting point (e.g. crossover)
- Start playing a test signal with energy in the subwoofer crossover region (e.g. pink noise) through all speakers
- While observing an SPL meter (or listening to the mid-bass level), have an assistant adjust the "VARIABLE PHASE" knob from 0° to 180° and observe any change in mid-bass level. Set the control to the position with the greatest amount of bass.
- Play a test signal (e.g. pink noise) through only 1 speaker at a time. If using your receiver, you may need to enter it's setup mode to perform this function.
- Place an SPL meter in your typical listening position, approximately at ear height (use of a tripod may be required), and set to "C" weighting and "Slow" response (if those settings are available)
- Adjust volume to a modest level ~ 75dB (loud enough to clearly hear, but not excessively loud)
- Adjust controls as necessary to play the same test tone through each speaker in the system, 1 speaker at a time
- Adjust the individual channel gain/trim of your equipment to obtain the same SPL reading from each speaker as you measured from the first speaker

A home theater receiver may walk you through portions of this procedure. Follow any instructions from your receiver's owner's manual as applicable to your system setup. Once finished, listen to some familiar music and movie tracks. Minor adjustment of the "BASS LEVEL" may be desired. Do not be afraid to experiment with slight adjustments to find what may improve the sound in your system!

At this point, if the subwoofer is placed in a good location & the controls have been properly set to blend the subwoofer's output with your main speakers, you should have a system that offers greatly improved low frequency response & dynamics, and the ability to play your system at higher volume levels with less distortion. Music should sound evenly balanced, deeper and very smooth. Movies will now have a much more realistic sense of involvement, especially in scenes with special effects such as car chases, airplanes, spaceships, explosions and more. Best of all, these KEN KREISEL DXD subwoofers equally combine the ability to reproduce the subtle nuances of a great music recording and the dynamics required for playing movies at theater levels inside your house.

PROTECTION CIRCUITRY

Your new subwoofer is equipped with special protection circuitry to provide maximum performance with greatest reliability.

The unit is protected against:

- 1) Overdriving the speaker or amplifier.
- 2) Overheating the amplifier.
- 3) Excessive drop in power line voltage.

The first type of protection circuitry which prevents overdriving of the speaker or amplifier operates constantly without being audible under most situations. In some extreme situations (e.g. sustained high output levels in warm environments), the unit may shut down momentarily. This indicates operation of the thermal or undervoltage protection circuitry. If this should happen, you should reduce the volume setting or shut the unit off until normal operating conditions return. You may also want to plug the unit into a different wall outlet (or circuit), as inadequate power line voltage & current will be most noticeable under high output conditions.

CARE OF YOUR SUBWOOFER

Your new subwoofer does not require any regular maintenance. Normal dusting or cleaning of the surface for appearance purposes is all that is required. Avoid using harsh detergents or chemicals when cleaning the cabinet. Abrasives, detergents, or cleaning solutions may damage the finish on the cabinet. We recommend using only a damp cloth or automotive grade "quick detailer" designed for painted surfaces, plastic & metal trim, to clean the cabinet.

During normal conditions, your new subwoofer may be left on continuously without any problems. The unit is equipped with a signal-sensing automatic turn on/off function that will automatically turn the unit on when a signal is present at the RCA inputs and turn off the unit after several minutes without signal present at the RCA inputs (if the panel mounted switch is set to "**AUTO ON/OFF**").

NOTE: the auto on/off signal sensing does not operate when using the XLR inputs - set the switch to "**ALWAYS ON**" when using XLR inputs. If you plan to leave the subwoofer unused for an extended period of time (e.g. when away on vacation), we recommend that you turn off the master power switch located on the lower rear panel.

TROUBLESHOOTING AND SERVICE

If you should experience a problem with the operation of your subwoofer, please check all of the following before seeking service. Following is a simple troubleshooting guide to assist you.

1. Verify unit is plugged in and power outlet used has proper AC voltage & current.
2. Is power switch on?
3. Is auto turn on/off properly set?
4. Is the subwoofer receiving an input signal from your source?
5. Have all controls on the subwoofer (volume, crossover, phase, etc.) been properly set?
7. Is the volume control properly set to match source signal?
8. If the subwoofer has been running at high levels for an extended period of time, one of the protection circuits may be engaged.
 - Does the built-in amplifier panel feel extremely hot?
 - Is your AC power line circuit sufficiently rated to supply adequate VA/wattage for full output?

If the protection circuitry is active, the unit may cycle on and off until operating parameters return to normal. Under more serious conditions, the unit may shut off completely. Normal operation will return upon cooling, but depending on the fault condition you may be required to turn the main power off for several minutes and then back on again to reset the unit.

The following conditions require service by a qualified technician:

1. The unit has been exposed to liquid.
2. The power cord has become damaged.
3. The unit does not appear to operate normally or exhibits a marked change in performance.
4. Part of the cabinet, drivers, or electronics have been physically damaged.

Thank you for your purchase!

For additional help visit our support page on the web at: www.kreisel.com/support.php

SPECIFICATIONS**DXD-808****DXD-12012**

DRIVER CONFIGURATION: KEN KREISEL PROFESSIONAL Push-Pull High Velocity Deep Bass Drivers

DRIVER SIZE:	8"	12"
MAGNET WEIGHT:	82 oz. (5.125 lbs.)	96 oz. (6.0 lbs.)
VOICE COIL:	2" Four Layer	2" Four Layer
IN-ROOM FREQUENCY RESPONSE:	15Hz - 250Hz	10Hz - 250Hz
LOW PASS CROSSOVER:	40Hz - 160Hz 12dB/octave	40Hz - 160Hz 12dB/octave
PHASE:	0°-180° variable	0°-180° variable
AMP POWER (Class D):	1250+ Watts Peak 750+ Watts Continuous	1250+ Watts Peak 750+ Watts Continuous
INPUTS:	1x Balanced XLR 2x Unbalanced RCA	1x Balanced XLR 2x Unbalanced RCA
INPUT IMPEDANCE:	XLR: 15k ohms RCA: 8k ohms	XLR: 15k ohms RCA: 8k ohms
OUTPUTS:	1x XLR direct pass thru (unbuffered)	XLR direct pass thru (unbuffered)
WARRANTY (parts & labor):	Five years	Five years
DIMENSIONS (H,W,D) (includes feet)	17 5/8" x 10 7/8" x 13"	23 3/4" x 15 3/8" x 19 3/8"
WEIGHT (approx.):	47 lbs. (21.3 kg)	78 lbs. (35.4 kg)

Specifications subject to change without notice.

For additional help visit our support page on the web at: www.kreiselsound.com/support.php